

# Bounding Volume Hierarchy

Myung-Soo Kim

Seoul National University

<http://cse.snu.ac.kr/mskim>

<http://3map.snu.ac.kr>

# Bounding Volumes

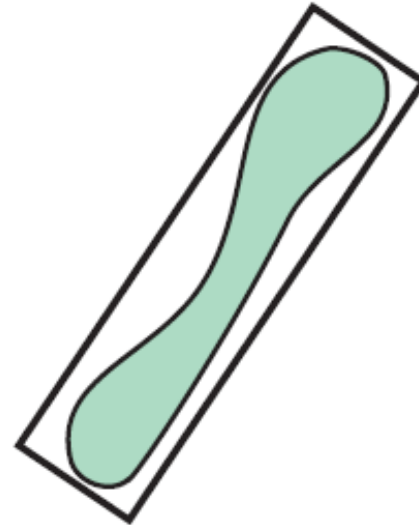
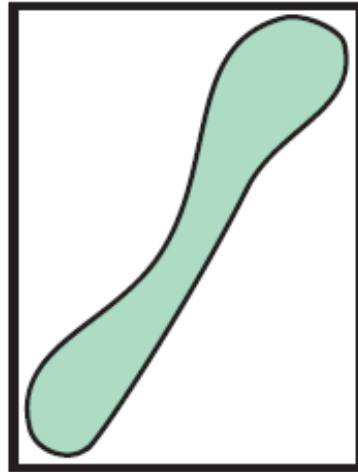
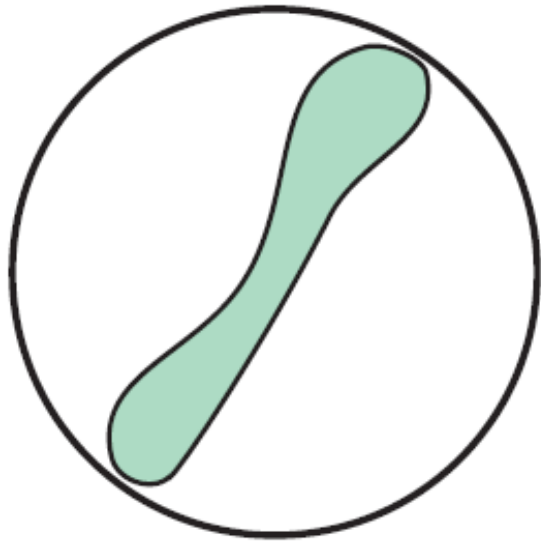

# Bounding Volume Hierarchy

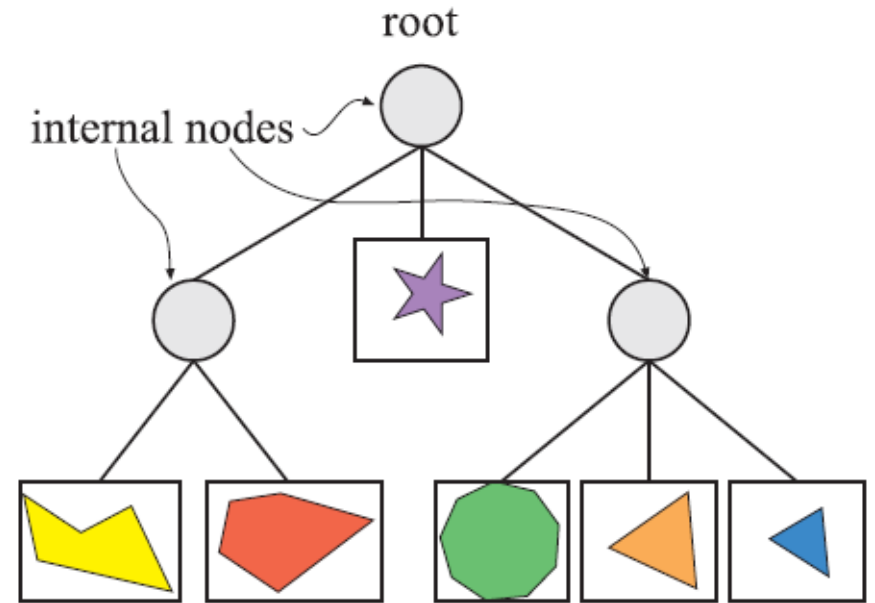
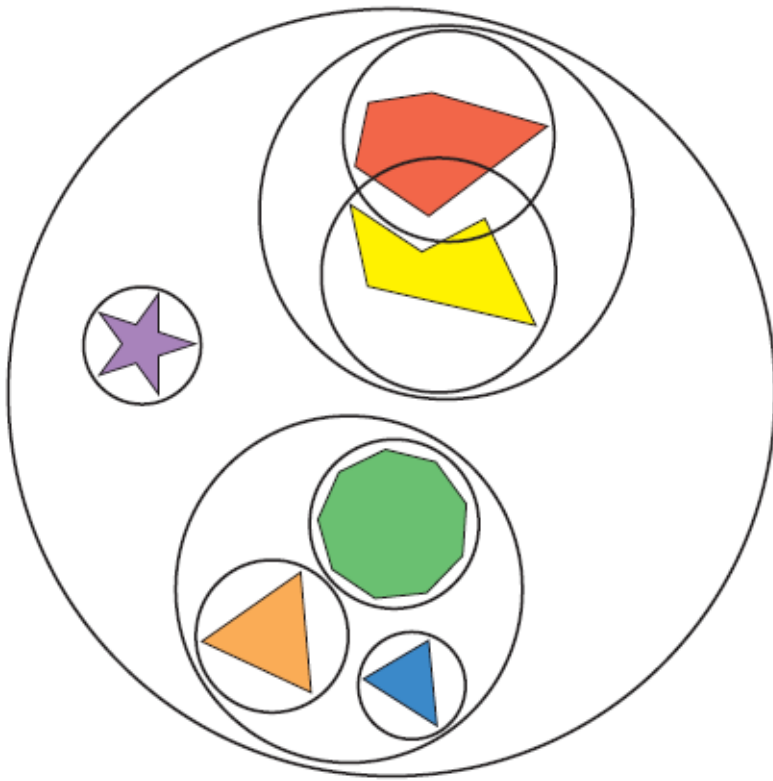

# Bounding Volume Hierarchy

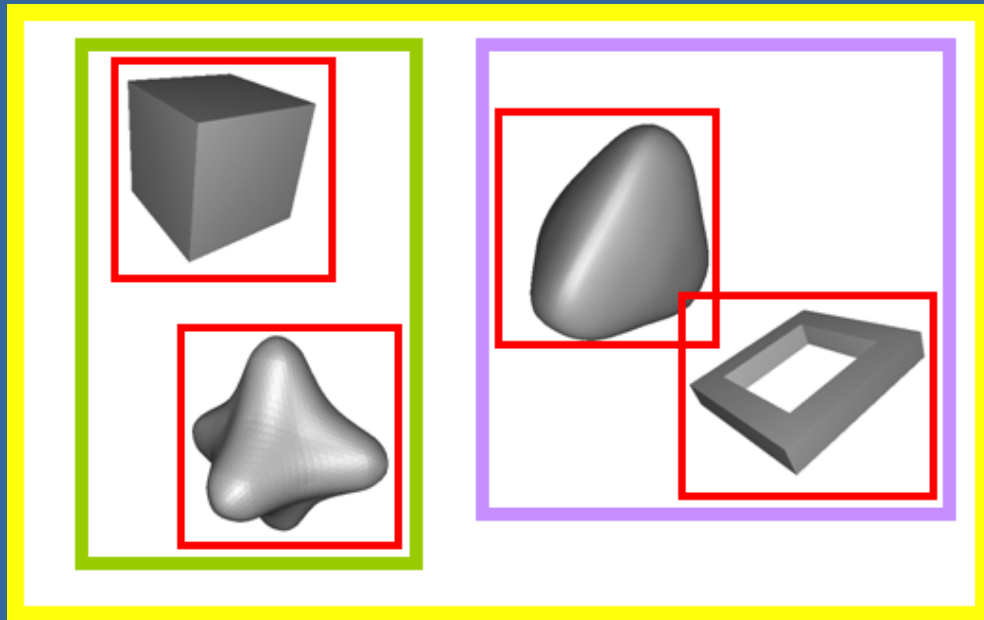

Data structure

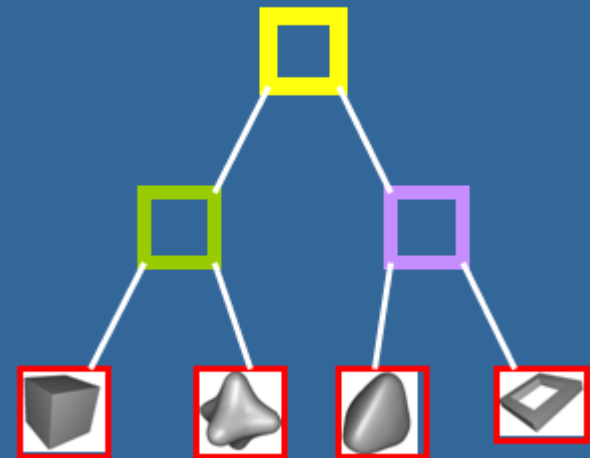

# BVH Construction for AABB

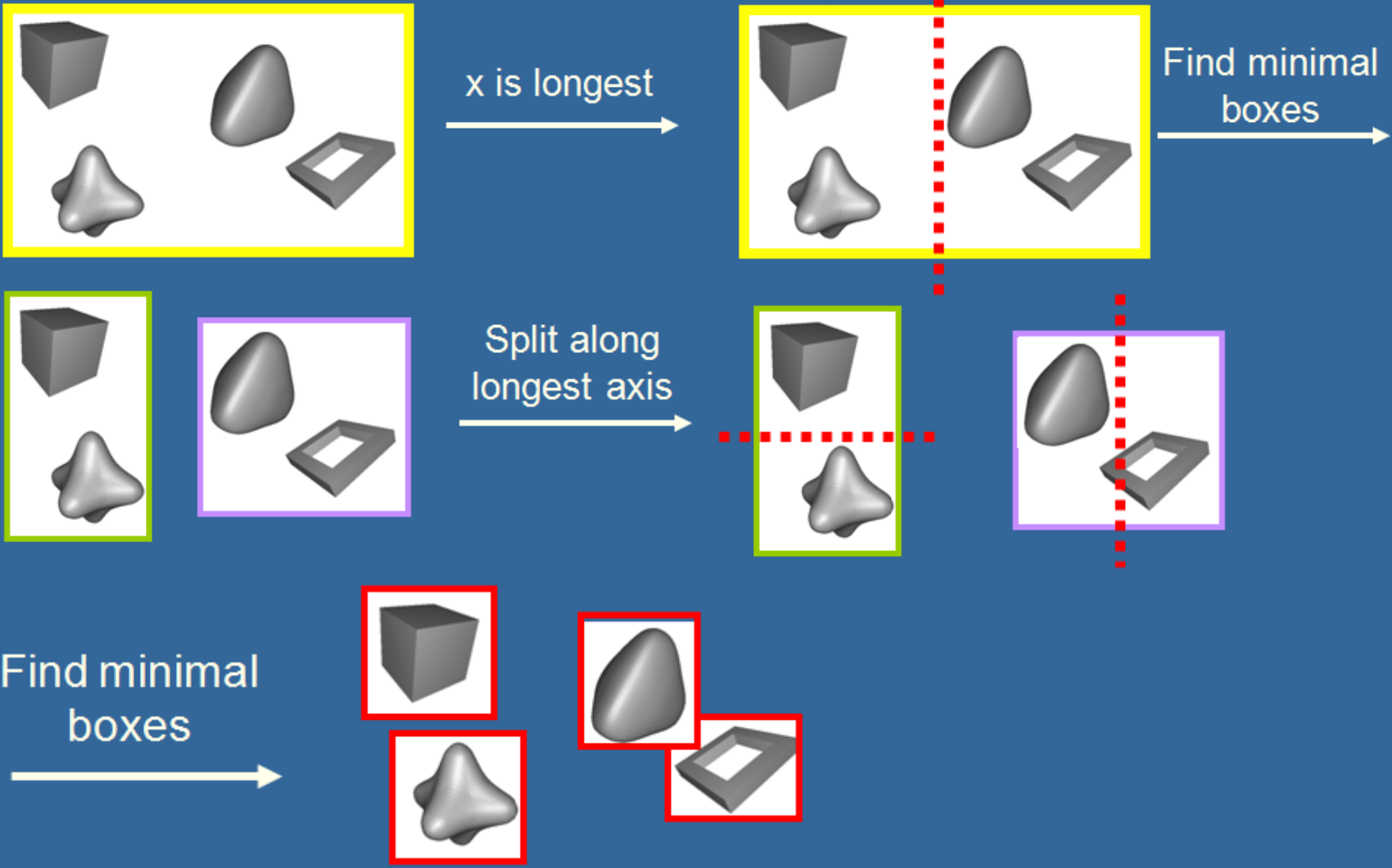

# OBB Construction

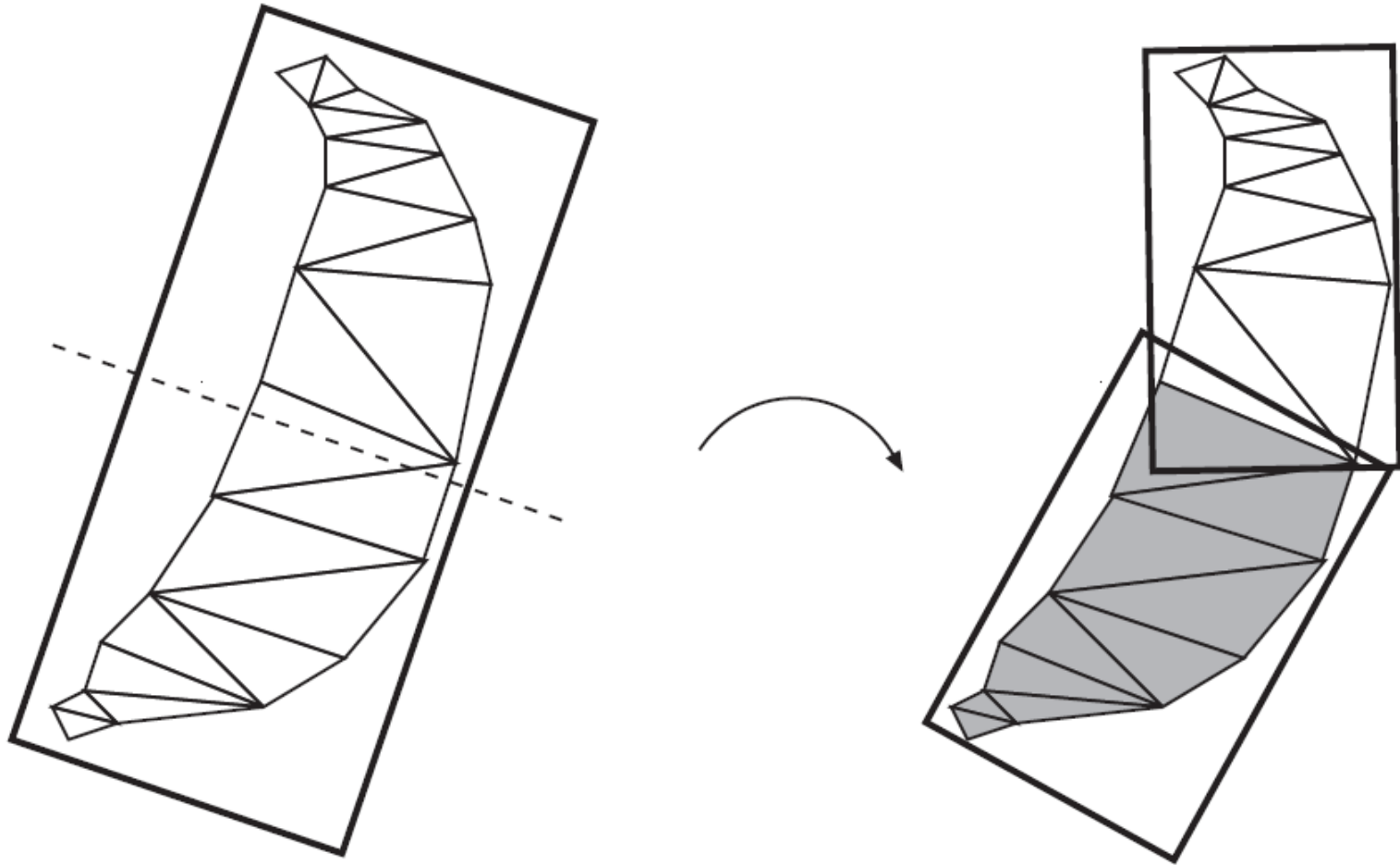

# BVH Complexity

Model	Triangles (M)	Size of BVH (MB)	Mean and std of depth of leaves	Comp. time (min)
Hugo	0.02	2	16, 1.7	0.03
Bunny	0.07	8	17, 0.8	0.26
Dragon	0.8	108	21, 1.6	3
1M power plant	1.1	139	23, 2.9	6
Turbine	1.7	220	22, 0.7	8
Lucy	28	4,811	37, 3.4	34

**Table 1:** *Benchmark Models: Model complexity, sizes of BVHs, mean and standard deviation(std) of depth of leaf nodes, and computation time to compute cache-oblivious layouts are shown.*

# Scene Graph

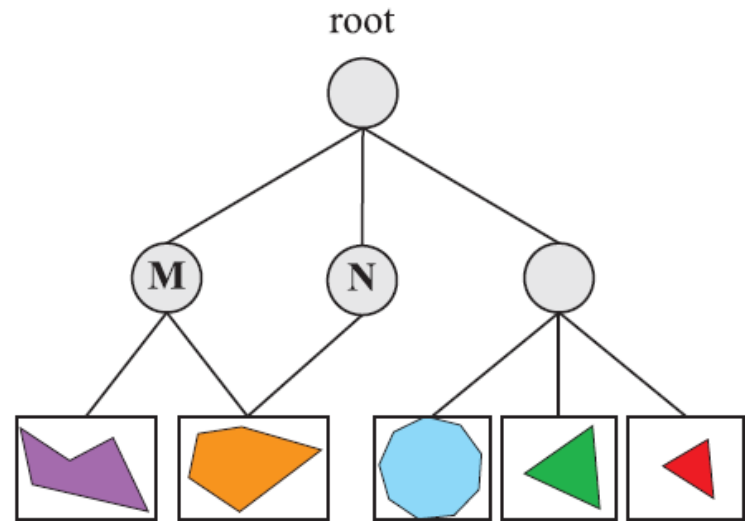
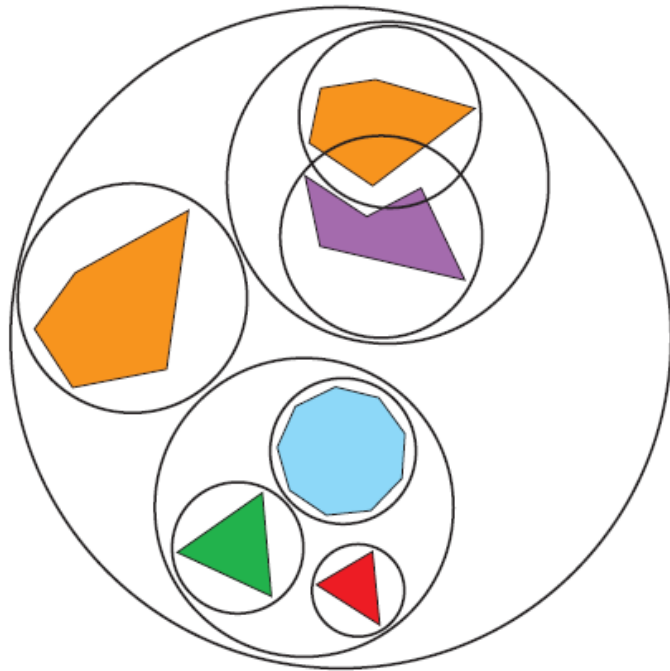



# View Frustum Culling

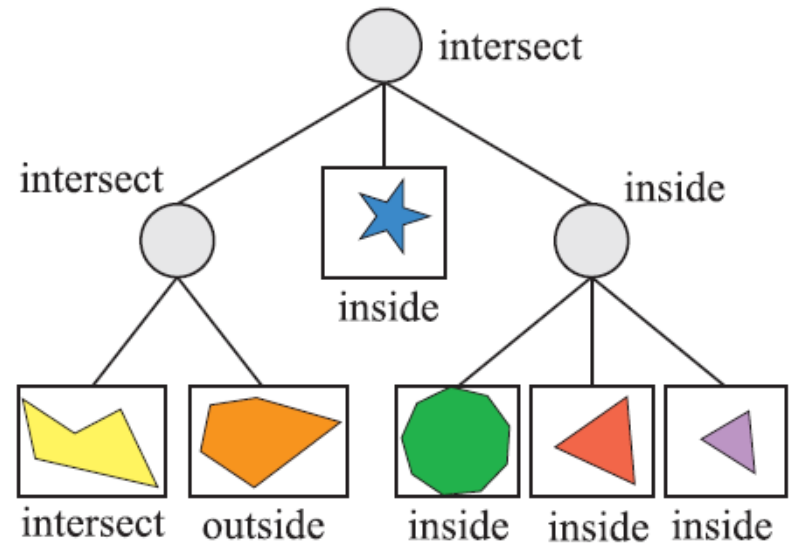
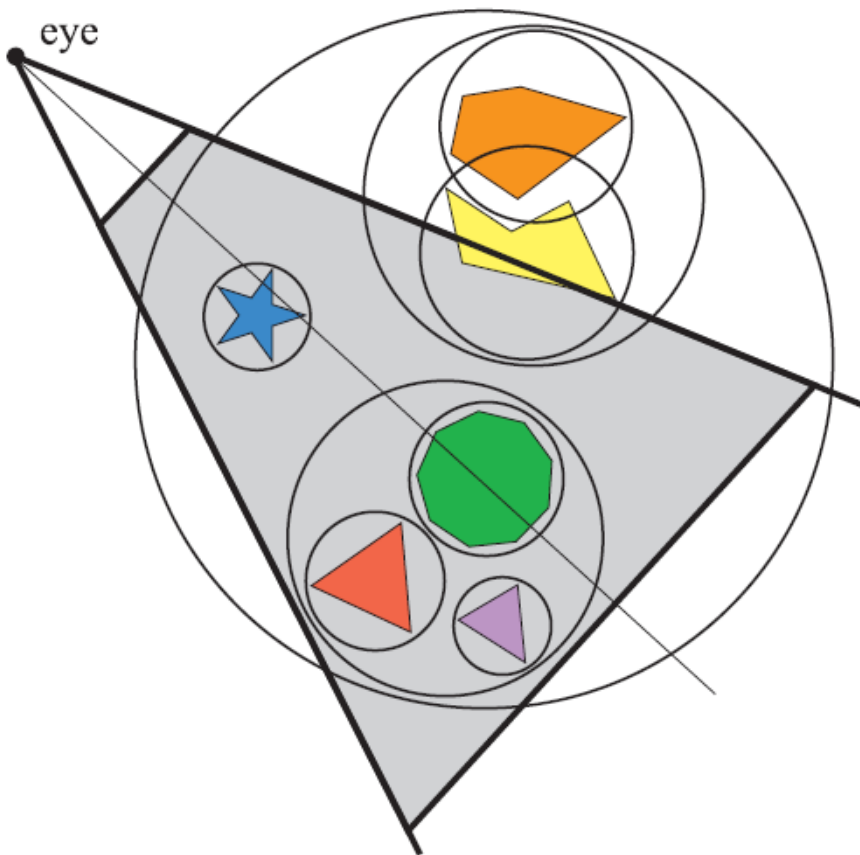

# Example of Hierarchical View Frustum Culling

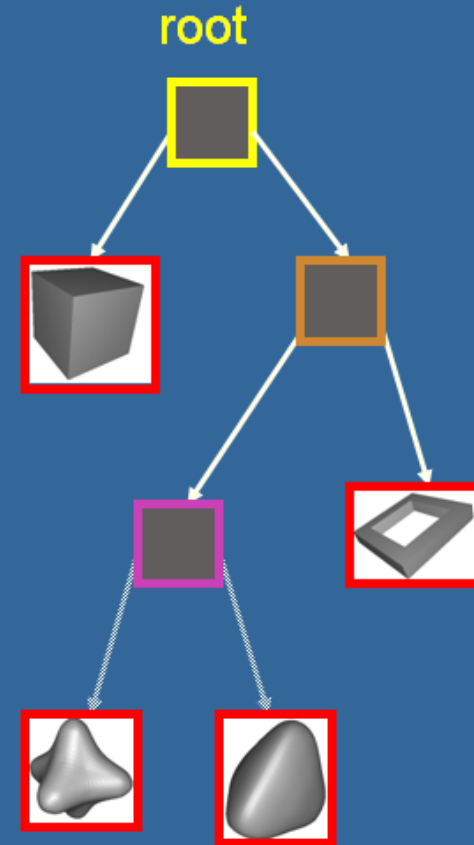
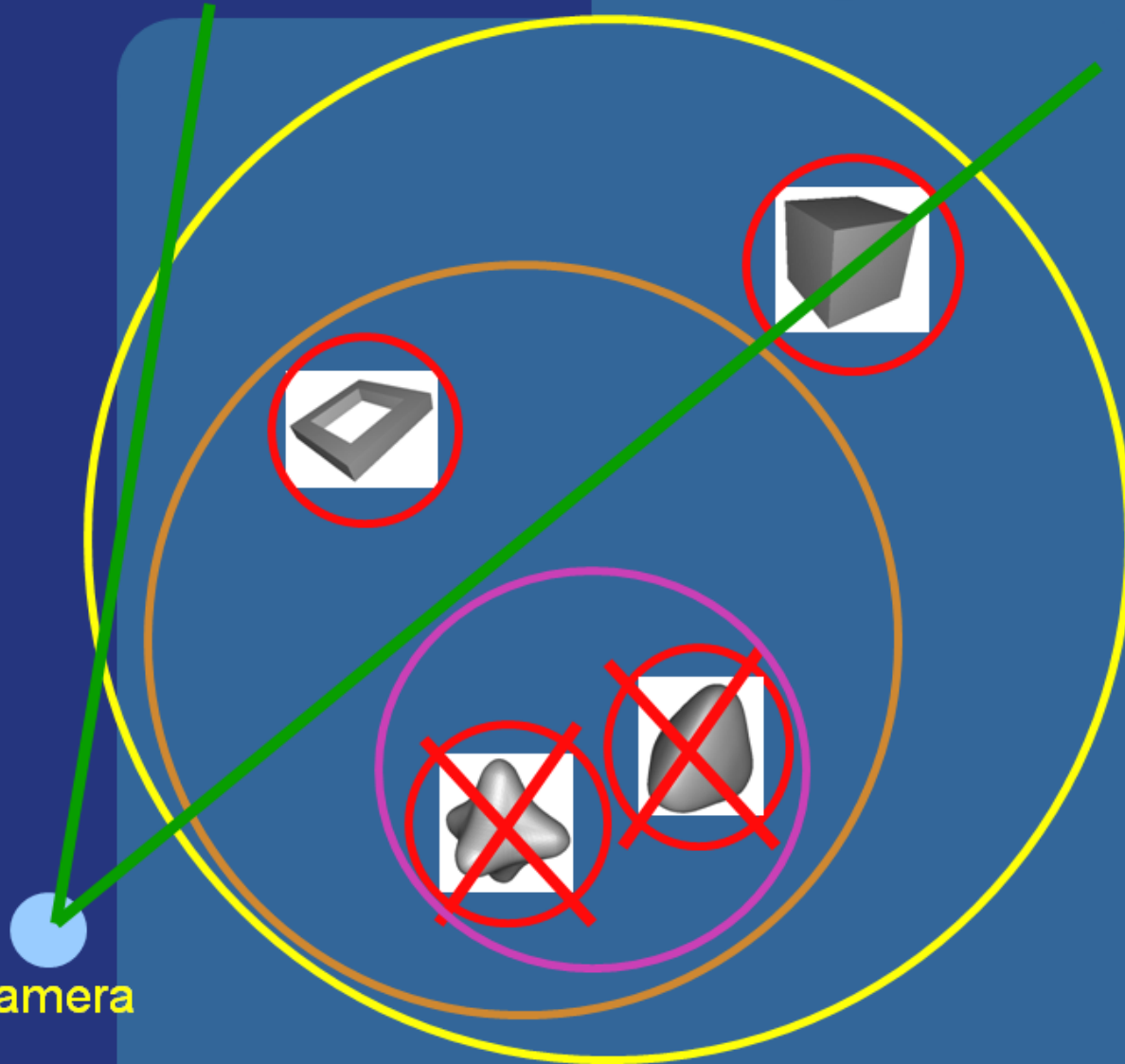

# View Frustum Intersection

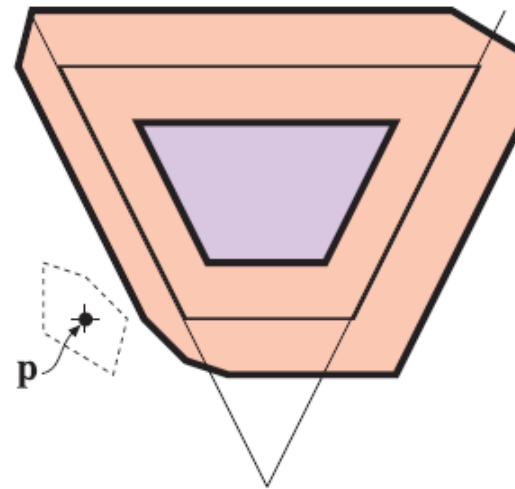
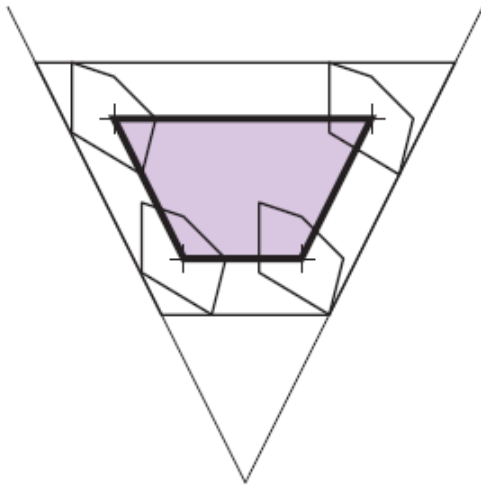
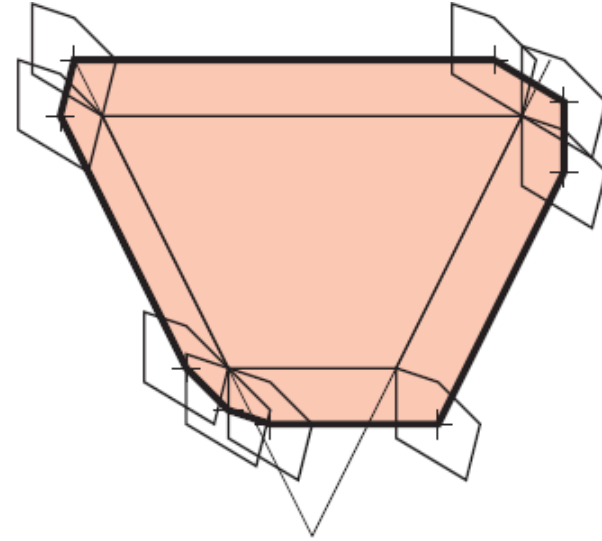
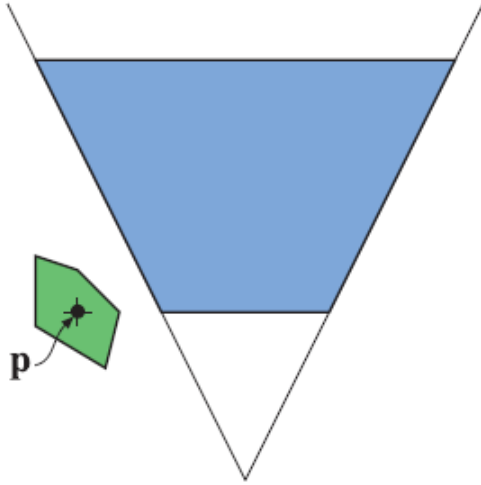

# View Frustum Intersection

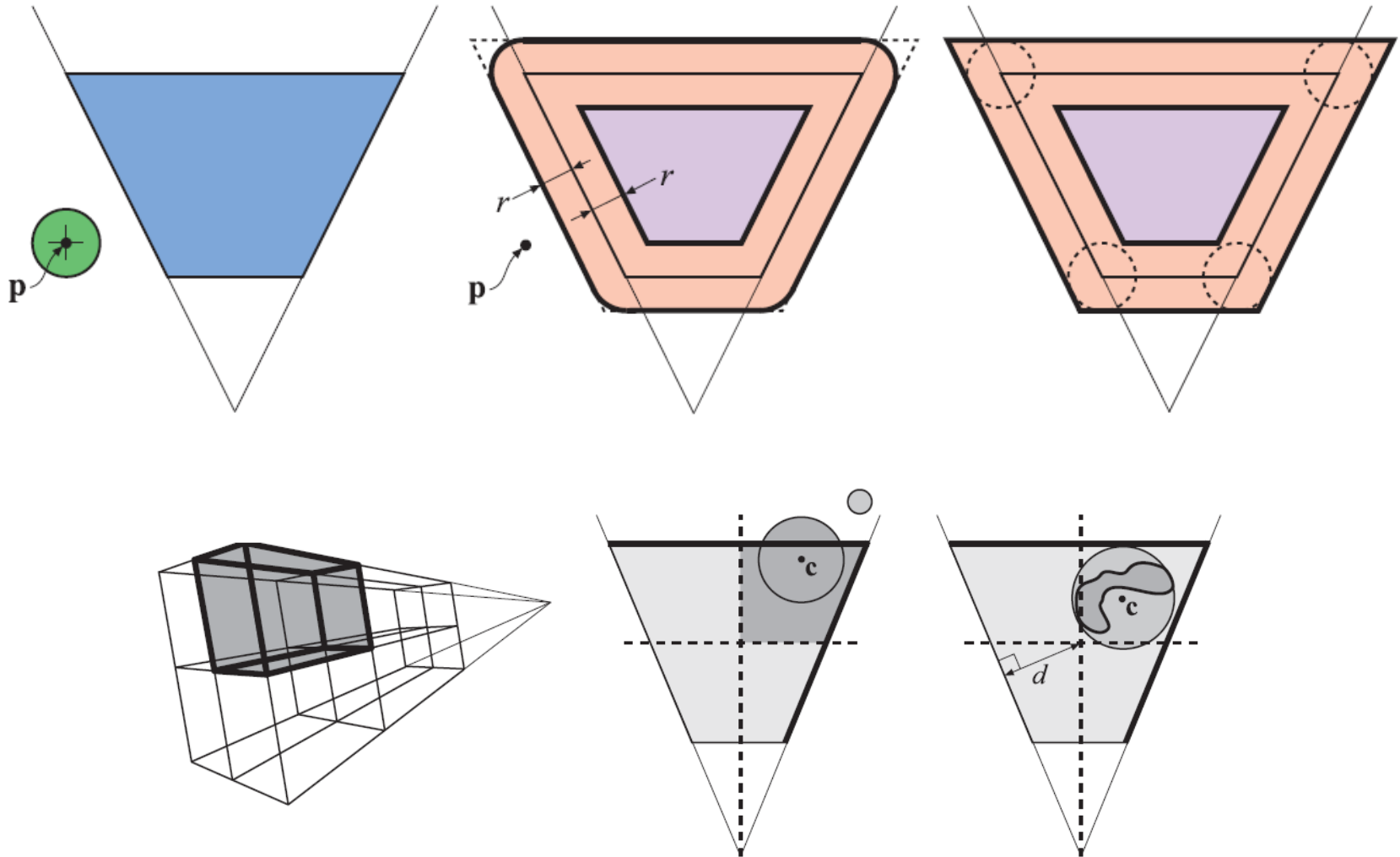

# Frustum/Box Intersection

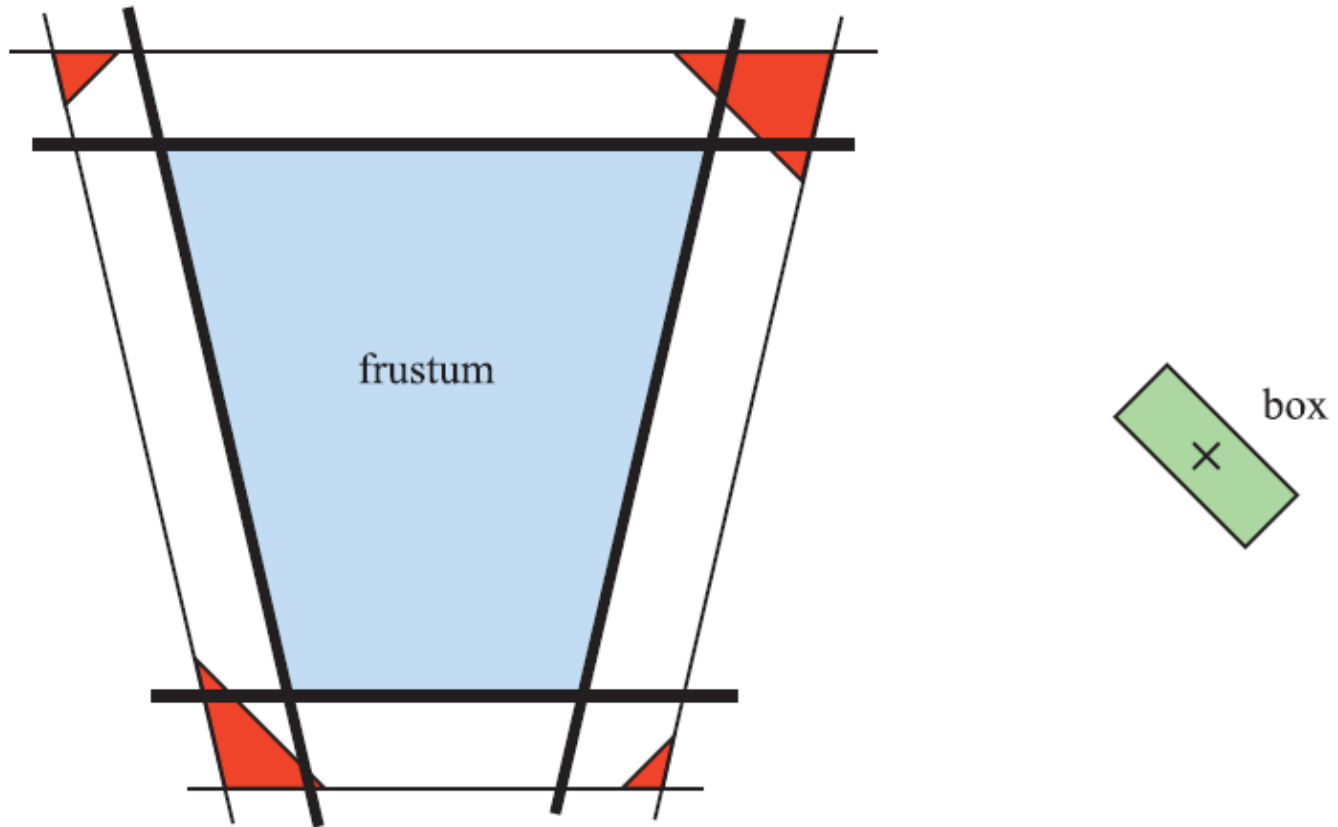

# Distance Queries

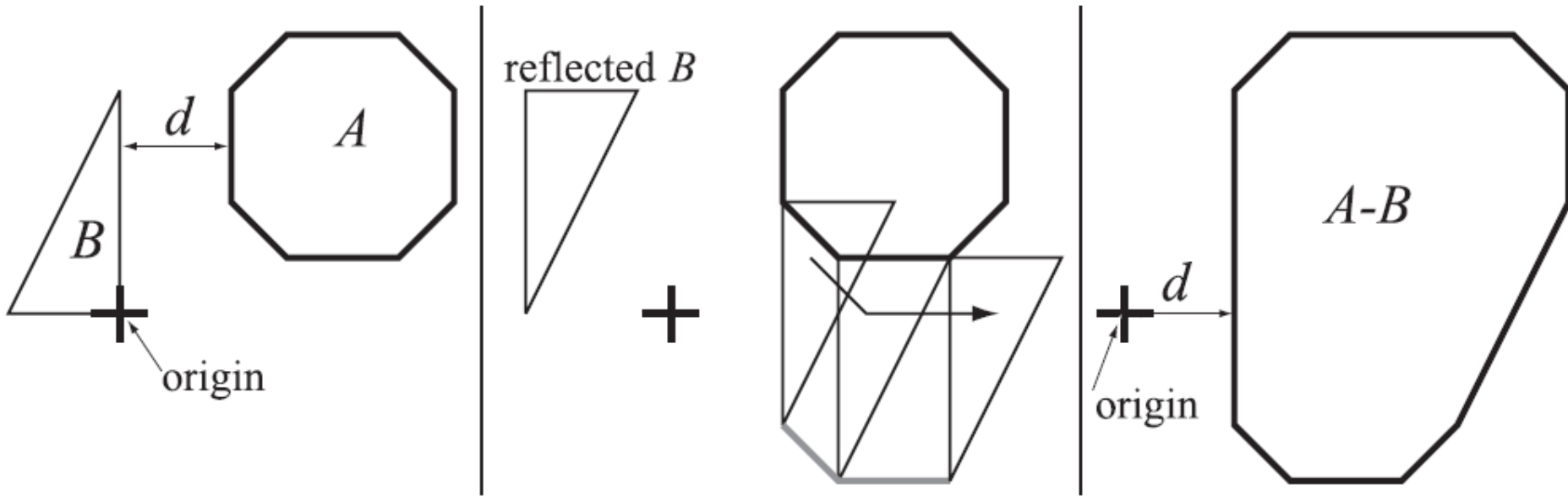

# GJK Algorithm for Convex Obj.

